

Rob Ives / robives.com

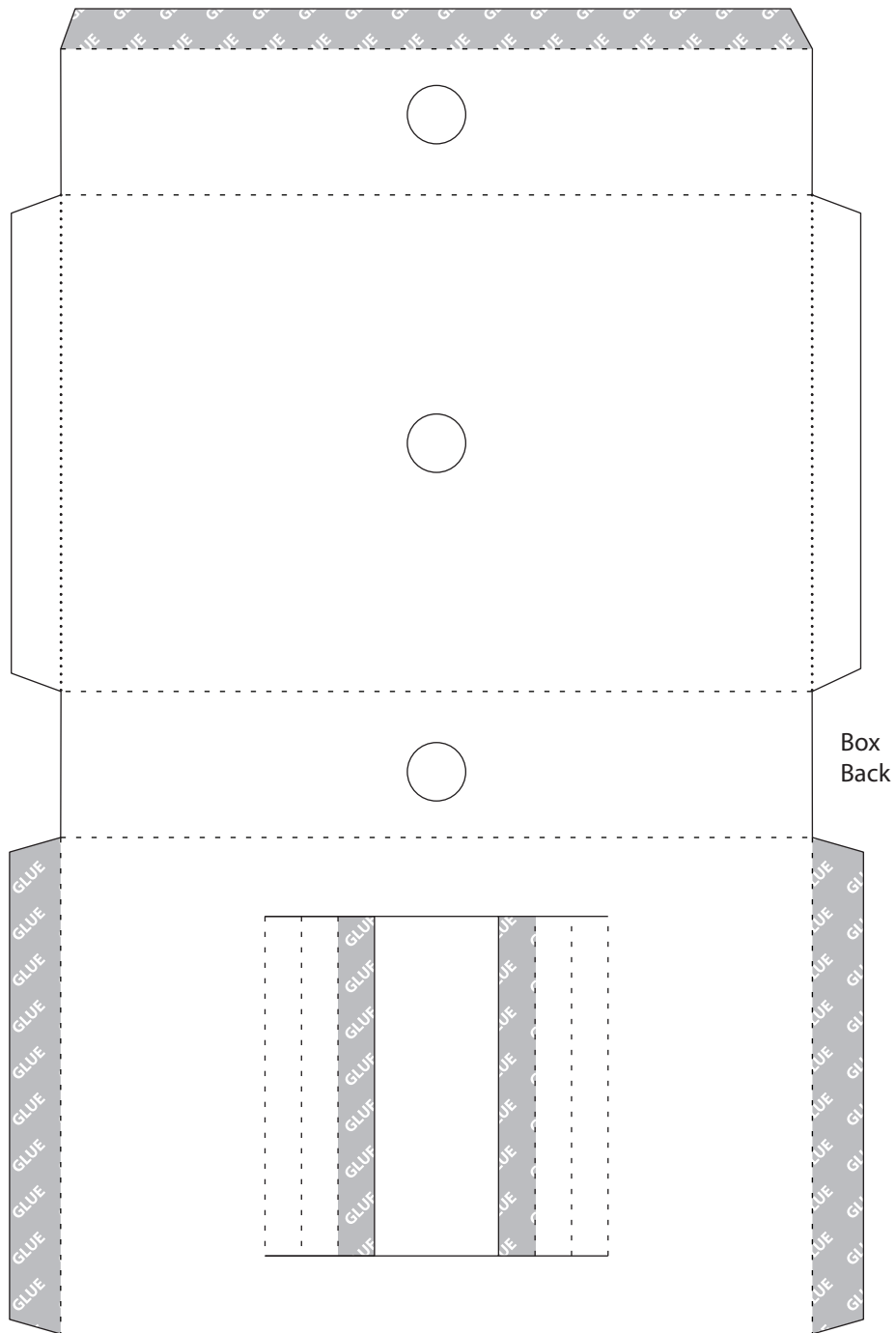

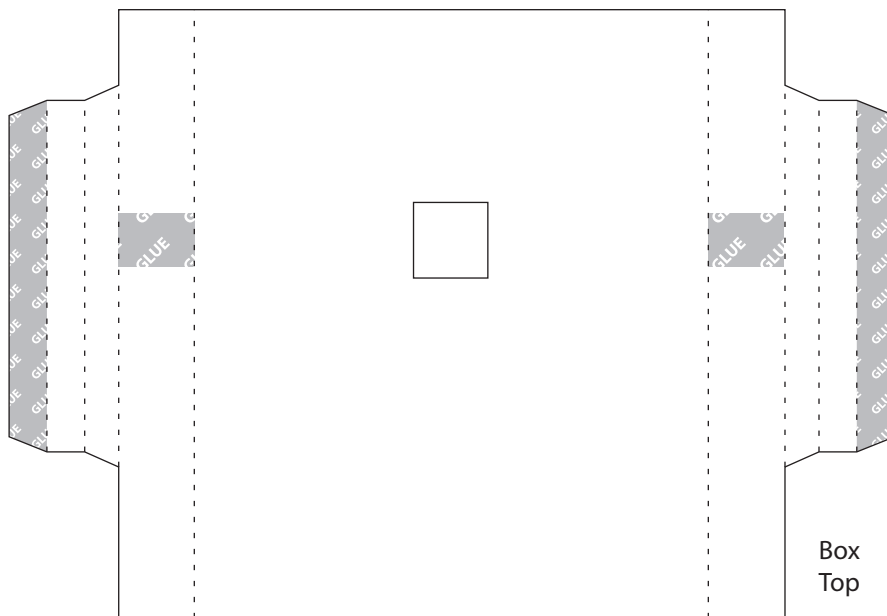

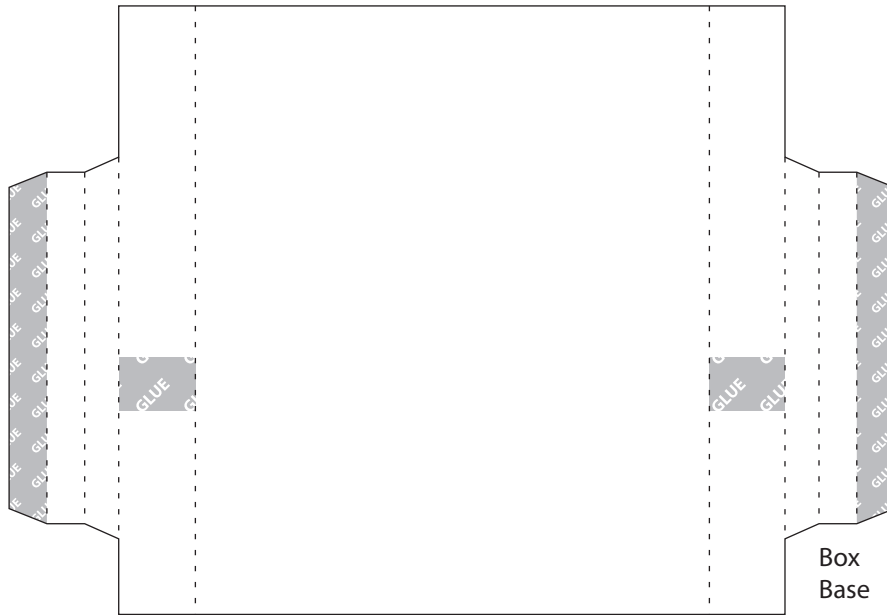

Push Rod Tube

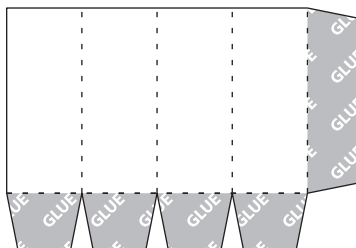

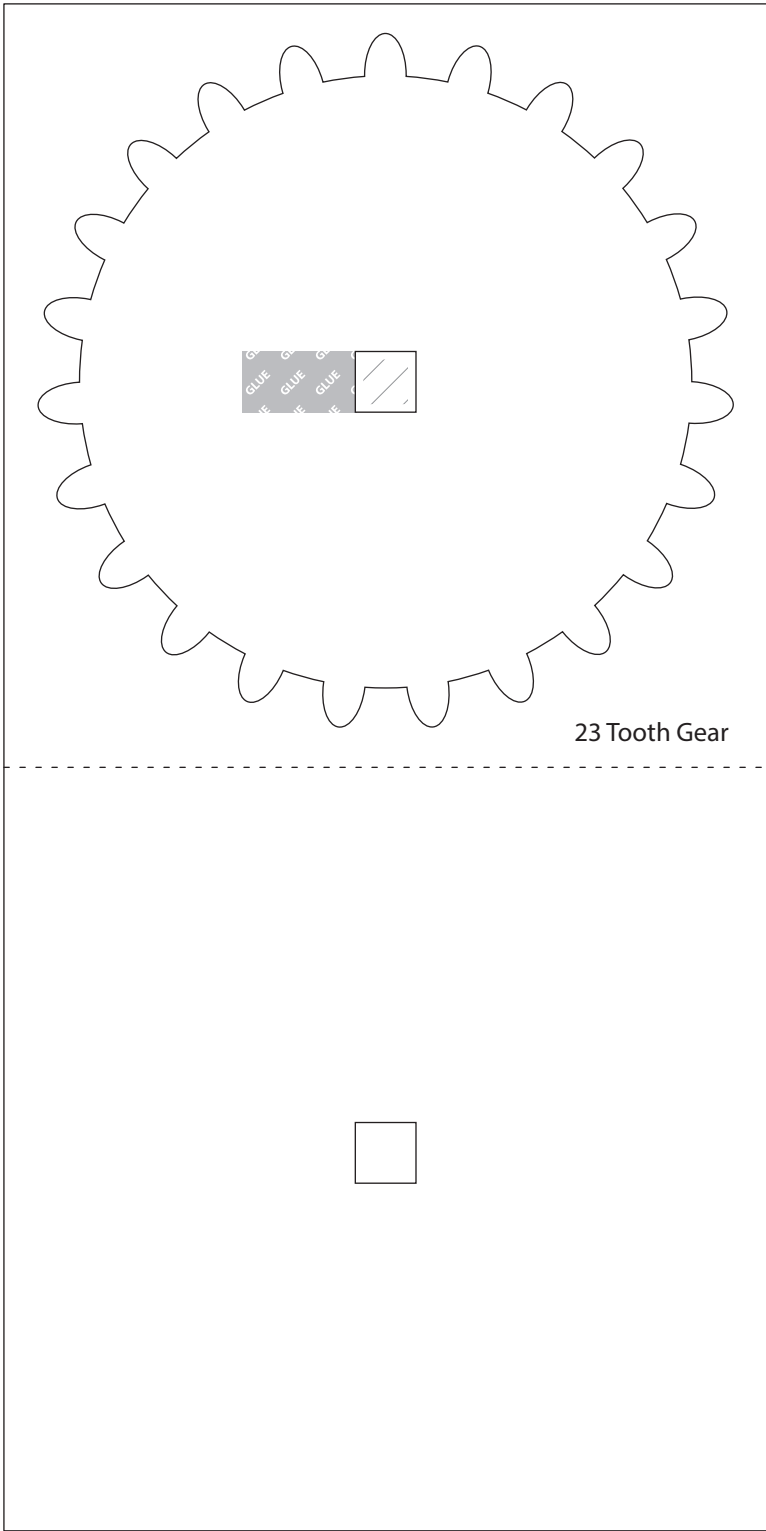

23 Tooth Gear

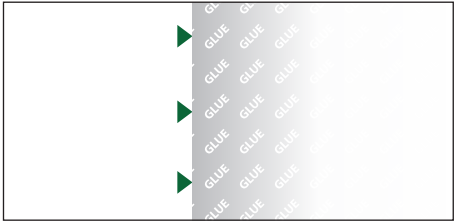

Axle Tubes

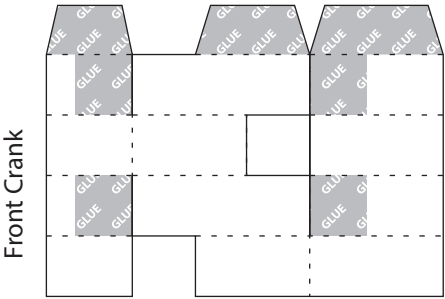
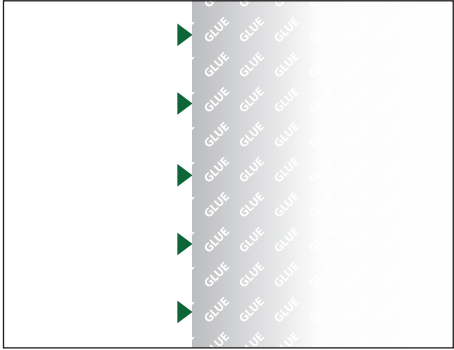

Front Crank

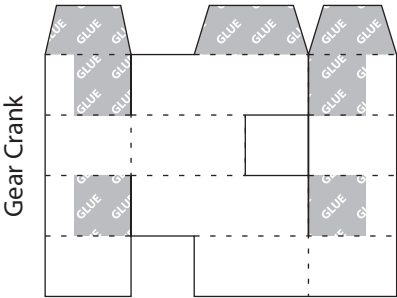

Gear Crank

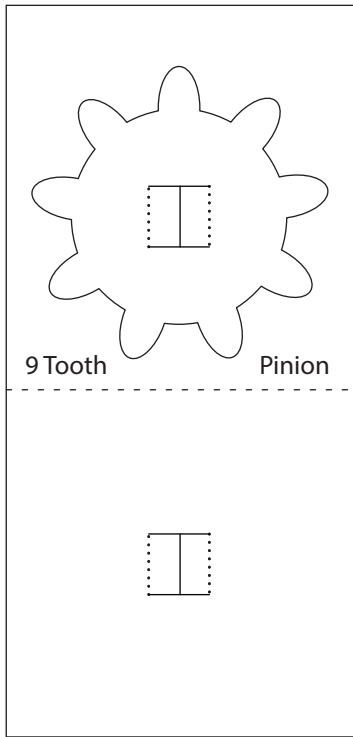

9 Tooth Pinion

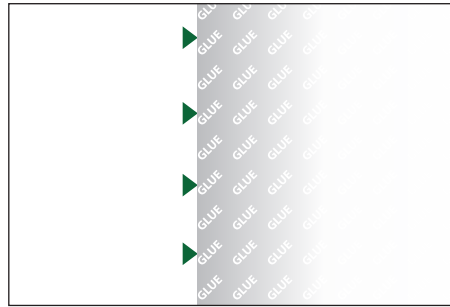

Axle Tubes

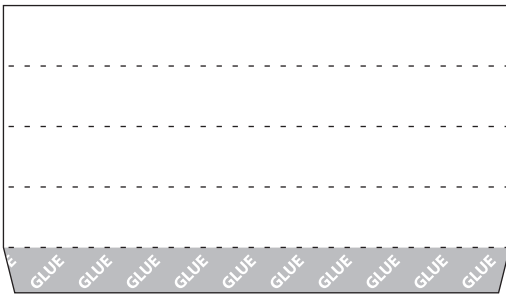
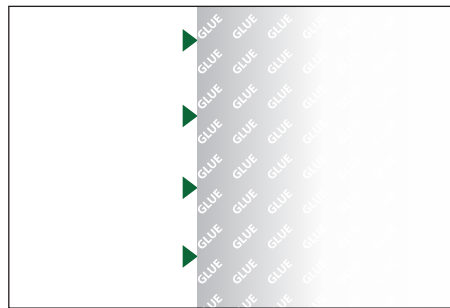

Long Pinion Axle

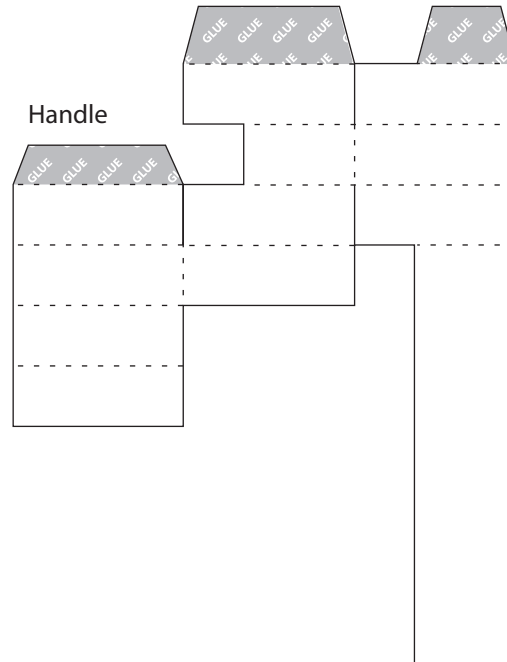

Handle

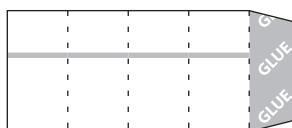

Short Pinion Axle

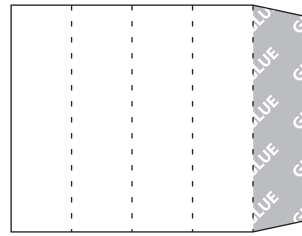
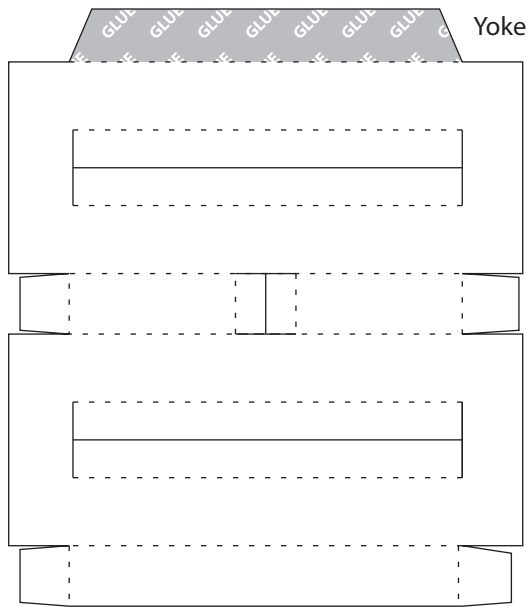

Pillar Slides

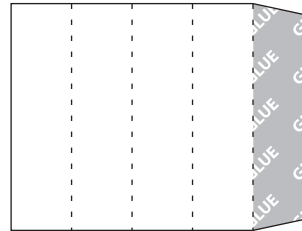

Push Rod

